

Getting Started With Your

A5L+

4G LTE mobile phone

Model: N5501L, A5L, A5L+

SUN CUPID declares that this device complies with the essential requirements and relevant provisions of the 2014/53/EU, 2014/30/EU and 2014/35/EU directives. Visit www.nuumobile.com to view the Declaration of Conformity.

SUN CUPID declares that the device complies with the International guidelines on exposure of radio waves. To check the values visit www.nuumobile.com.

nuu
mobile

Index

A5L+ Overview	3
Setting up Your Phone	4
Getting Started	6
Safety information	8
Certificate	12
Warranty information & Registration	15
Customer Support	15

A5L+ Overview

Front/Back



Top

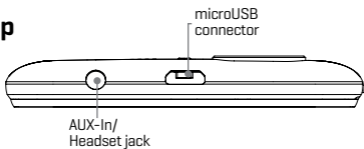

Bottom

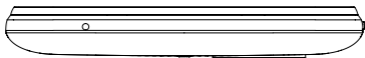

Setting Up Your Phone

Follow these step-by-step instructions to set up your A5L+. Power off the phone **before** inserting any cards!

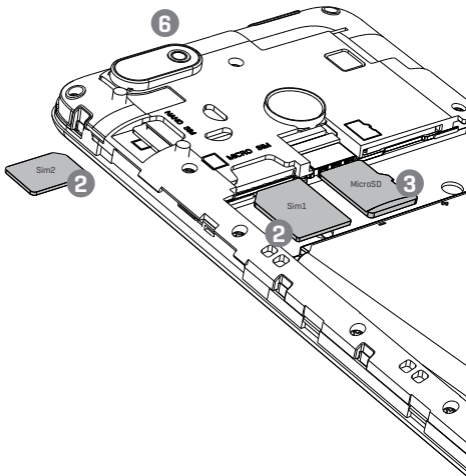

1 Remove Back Cover

- Remove the back cover by prying the lower left corner of your device.

2 Insert SIM

- Orient SIM card to match diagram on slot.
- SIM 1 (Micro) and SIM 2 (Nano) both support 4G LTE connections. However, they do not support simultaneous 4G LTE.

3 Insert microSD™ Memory Card (Optional)

- Remember to power off the phone and remove battery before inserting memory card.

4 Insert the Battery

- Align the battery contacts, then insert the battery contact-first.

5 Replace Back Cover

- After installing the SIM card, memory card, and battery, align the cover and snap it closed. Be sure to press all around the edges to ensure a secure fit.

6 Charge/Sync

- Plug in the microUSB connector to charge the phone or transfer data.

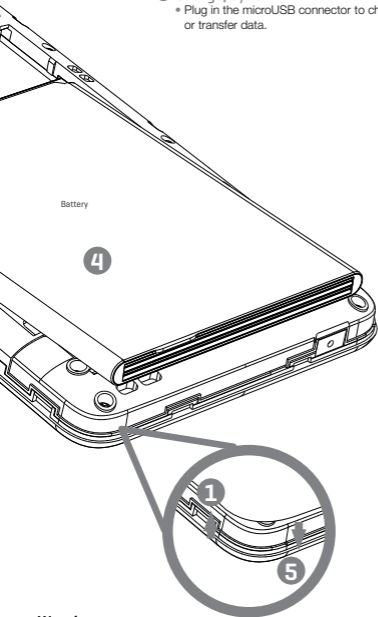



Warning:

SIM cards are small enough to become a choking hazard, so please keep them away from Children & Pets. SIM cards are also quite delicate. Please be careful when handling your card.

Getting Started



How to use the phone keys

In any screen, tap the back key " to return to previous screen or exit the application. Tap the home key " to return to the home screen. Tap the recent key " to display all the programs that are currently in use. Tap the "on/off" button, to turn on or off the screen and lock the screen. Long press "on/off" to shut down or to restart your mobile device. Press and hold the "on/off" button and the volume down key at the same time to take a screen capture.



Language

Tap the settings icon. Scroll down under "Personal" and tap "Language & input", then select your preferred language by tapping "Language".

Calls

Tap the "Phone" icon, then tap on " to select the contact you would like to call. Or, simply make a call by entering the number after selecting the " icon.

Android™ Messages

Tap the Android Messages icon, then tap " to create a new message. Input a name or number into the "To" field or choose someone from your contact list, then tap "", and input your message. Press the paperclip icon if you want to attach a picture, video or other media. When done, tap "Send".

Writing and copying a text

The phone will make recommendations as you type. If you want to copy or cut text, long press the text for a few seconds and use the selecting arrows to select, or use the "select all" option, then copy or paste your text.

Camera

Tap the "camera" icon to open the camera. The phone supports a variety of picture modes such as HDR, flash, Face beauty etc. To access these modes, select the "options" icon.



Google™ Photos

Tap the Google Photos icon in the Google folder to open the gallery to browse your photos, tap on a photo to open it. Tap " to enter edit mode. You can add color filter effects, rotate, crop and so on. Click "save".

Video camera

Tap the "camera" icon to open the camera and switch to "video" mode by tapping " to record.

Gmail

Tap the Gmail icon in the Google folder. Then select the " icon in the lower right corner to compose a new message. Use the paperclip to attach files or images. Tap on " when done. **Note:** You must set up an email account first.

Google Play Music

Tap the Google Play Music icon in the Google Folder. Select the playlist or song you would like to play. Playlists can be categorized by Artist, Albums, Genre or what you have created.

FM Radio

Connect earphones to the audio jack, tap the "FM Radio" icon in All Apps " and select frequency.

Primeros pasos

¿Cómo usar las teclas del teléfono?

Desde cualquier pantalla, toque la tecla para ir hacia atrás "<" y regresará a la pantalla anterior o saldrá de la aplicación. Toque la tecla de inicio "□" para regresar a la pantalla de inicio. Toque la tecla con el cuadrado "□" para ver todos los programas que están en uso. Toque el botón de encendido/apagado "on/off", para encender o apagar la pantalla o para bloquearla. Presione durante unos segundos el botón "on/off" para apagar o reiniciar su dispositivo. Mantenga presionado el botón "on/off" y la tecla de volumen al mismo tiempo para obtener una captura de la pantalla.

Idioma

Toque el ícono de configuraciones. Baje hasta la opción "Personal" y toque "Idioma & Entrada", luego toque "Idioma" para seleccionar su idioma de preferencia.

Llamadas

Toque el ícono del "Teléfono", luego toque "👤" para seleccionar el contacto al que desea llamar. O, simplemente haga una llamada ingresando el número de teléfono luego de seleccionar el ícono "☎".

Mensajes Android™

Toque el ícono de Mensajes Android Messages, luego toque "✉" para crear un nuevo mensaje. Ingrese el nombre o el número en el campo "Para" o elija algún contacto de su lista, luego toque "✓" e ingrese su mensaje. Presione el ícono con el clip si desea adjuntar una imagen, video u otro archivo multimedia. Cuando haya terminado presione "Enviar".

Escritura y copiado de mensajes

El teléfono le hará recomendaciones a medida que vaya escribiendo. Si desea copiar o cortar texto, presione durante algunos segundos el texto y use las flechas de seleccionado o elija la opción "seleccionar todo", y luego copie su texto.

Cámara

Toque el ícono de la "cámara" para abrir la cámara. El teléfono soporta distintos modos de imágenes como por ejemplo HDR, flash, Face beauty, etc. Para acceder a estos modos, seleccione el ícono de "Opciones".

Fotos de Google™ (Google Photos)

Toque el ícono de Google Photos dentro de la carpeta Google para abrir la galería y ver sus fotos. Toque una foto para abrirla. Toque "✍" para ingresar al modo de edición. Se pueden agregar efectos de filtros de color, rotación, recortado, entre otras cosas. Haga clic en "Guardar".

Cámara de video

Toque el ícono de "Cámara" para abrir la cámara y para cambiar al modo de "Video" toque "□" para grabar.

Gmail

Toque el ícono de the Gmail en la carpeta de Google. Luego seleccione el ícono "✉" que se encuentra en la esquina inferior a la derecha para componer un nuevo mensaje. Use el clip para adjuntar imágenes o archivos. Toque "➤" cuando haya terminado.
Nota: Deberá contar con una cuenta de correo electrónico antes de realizar estos pasos.

Reproductor de música "Google Play Music"

Toque el ícono de Google Play Music en la carpeta de Google. Seleccione una lista de temas o una canción que desee reproducir. Las listas de temas se pueden categorizar por artista, género o por una categoría creada por usted.

Radio FM

Conecte los auriculares en el enchufe, toque el ícono de "Radio FM" en todas las aplicaciones "📶" y elija la frecuencia.

Guide de démarrage

Comment utiliser les touches du téléphone

Depuis n'importe quel écran appuyez sur la touche "<" pour retourner à l'écran précédent ou sortir de l'application. Appuyez sur la touche "O" pour retourner à l'écran d'accueil. Tapez sur "□" pour afficher tous les programmes en cours d'utilisation. Appuyez sur le bouton "Marche/Arrêt" pour allumer, éteindre ou verrouiller l'écran. Appuyez de manière prolongée sur le bouton "Marche/Arrêt" pour éteindre ou redémarrer votre téléphone. Maintenir appuyées les touches "Marche/Arrêt" et "Volume -" simultanément pour effectuer une capture d'écran.

Langues

Appuyez sur l'icône des paramètres Faites défiler vers le bas jusqu'à "Personnel" et appuyez sur "Langues et saisie" puis appuyez sur "Langues" et sélectionnez la langue de votre choix.

Appels

Appuyez sur l'icône "Téléphone", ensuite appuyez sur la touche "☎" pour sélectionner le contact que vous souhaitez appeler. Ou saisissez simplement le numéro de votre correspondant après avoir sélectionné l'icône "☎".

Android™ Messages

Appuyez sur l'icône Android Messages, puis tapez sur la touche "+" pour rédiger un nouveau message. Saisissez le nom ou le numéro de téléphone du destinataire dans le champ "à" ou choisissez un contact dans votre répertoire, appuyez sur "✓" et saisissez votre message. Appuyez sur l'icône "pièce jointe" pour joindre une photo, une vidéo ou autres, et taper sur "envoyer" lorsque c'est fait.

Saisir et copier un texte

Le téléphone fera des recommandations pendant la saisie. Si vous souhaitez copier ou couper du texte, appuyez sur le texte durant quelques secondes et utiliser les flèches pour sélectionner, ou utilisez l'option "tout sélectionner", puis copiez ou collez votre texte.

Appareil photo

Appuyez sur l'icône "appareil photo" pour l'allumer. Le téléphone comprend un ensemble de modes photo tels que HDR, flash, Face Beauty etc. Pour accéder à ces modes, appuyez sur l'icône "options".

Google™ Photos

Appuyez sur l'icône de Google Photos se trouvant dans le dossier Google pour ouvrir la galerie vous permettant d'explorer vos photos, appuyez sur une photo pour l'ouvrir. Appuyez sur "✎" pour vous mettre en mode édition. Vous pouvez rajouter des filtres de couleur, faire pivoter, couper etc. Appuyez sur "sauvegarder".

Caméra vidéo

Appuyez sur l'icône "appareil photo" pour ouvrir la caméra et passer en mode vidéo en appuyant sur "📹" pour commencer à enregistrer.

Gmail

Appuyez sur l'icône Gmail se trouvant dans le dossier Google. Sélectionnez l'icône "✉" en bas à droite de l'écran pour rédiger un nouveau message. Utilisez l'icône "pièce jointe" pour joindre des fichiers ou des images. Appuyez sur "➤" lorsque vous aurez terminé. **Remarque:** Vous devez d'abord créer un compte de messagerie.s

Google Play Music

Appuyez sur l'icône Google Play Music se trouvant dans le dossier Google. Sélectionnez la liste de lecture ou le morceau que vous voulez écouter. Les listes de lectures peuvent être organisées par Artiste, Album, Genre ou ce que vous avez créé.

Radio FM

Brancher des écouteurs sur la prise audio, appuyez sur l'icône "Radio FM" dans le lanceur "⋮" et sélectionnez la fréquence désirée.

Erste Schritte

Bedienung der Tasten des Smartphones

Tippen Sie auf die Zurück-Taste (back key) „<“ um aus einer Ansicht zur vorherigen zurückzukehren, oder um eine Anwendung zu verlassen. Tippen Sie auf die Home-Taste (home key) „○“ um zur Hauptansicht zurückzukehren. Tippen Sie auf die Menü-Taste (recent key) „☰“ um alle Anwendungen darzustellen, die aktuell in Gebrauch sind. Tippen Sie auf die An-Aus-Taste (on/off button), um den Bildschirm an- oder auszuschalten sowie um den Bildschirm zu sperren. Längeres Drücken der An-Aus-Taste führt zum Ausschalten oder Neustart Ihres mobilen Gerätes. Halten Sie gleichzeitig die An-Aus-Taste und die Leiser-Taste gedrückt, um ein Foto einer Ansicht zu machen.

Sprache

Tippen Sie auf das „Einstellungen“-Symbol. Scrollen Sie zu „Persönlich“ (Personal) und tippen Sie auf „Sprache & Eingabe“ (Language & Input). Wählen Sie dann Ihre bevorzugte Sprache indem Sie auf „Sprache“ tippen.

Anrufe

Tippen Sie auf das Telefon-Symbol (Phone) und dann auf „☎“ um den Kontakt auszuwählen, den Sie anrufen möchten. Es ist einfacher jemanden anzurufen, indem Sie die Nummer eingeben, nachdem Sie das Symbol „☎“ auswählen.

Android™ Messages

Tippen Sie auf das „Android Messages“-Symbol und dann auf „+“, um eine neue Nachricht zu erstellen. Geben Sie einen Namen oder eine Nummer in das Feld „An“ (To field) ein, oder wählen Sie jemanden aus Ihrer Kontaktliste und tippen Sie auf „✓“. Geben Sie dann Ihre Nachricht ein. Drücken Sie auf das Büroklammer-Symbol falls Sie ein Bild, Video oder eine andere Datei anhängen wollen. Wenn Sie fertig sind, tippen Sie auf „Absenden“ (Send).

Schreiben und Kopieren von Text

Während Sie etwas eintippen, wird das Smartphone Vorschläge machen. Wenn Sie Text kopieren oder ausschneiden wollen, drücken Sie einige Sekunden lang auf den Text und wählen sie einen der Auswahlpfeile. Oder benutzen Sie die „Alles auswählen“-Option (select all) und kopieren Sie dann Ihren Text, oder fügen Sie ihn ein.

Kamera

Tippen Sie auf das „Kamera“-Symbol um die Kamera-App zu öffnen. Das Smartphone unterstützt eine Vielzahl an Bildmodi, wie zum Beispiel HDR, Blitzlicht, „Face beauty“ und weitere. Um auf diese Modi zuzugreifen, wählen Sie das „Optionen“-Symbol (options).

Google™ Fotos

Tippen Sie auf das „Google Fotos“-Symbol im Google Ordner um die Galerie zu öffnen. Sehen Sie hier Ihre Fotos an und tippen darauf, um eines zu öffnen. Tippen Sie auf „✎“, um in den Editiermodus zu kommen. Sie können einen Farbfiltereffekt hinzufügen, das Foto drehen, zuschneiden und vieles mehr. Klicken Sie dann auf „Speichern“ (save).

Videokamera

Tippen Sie auf das „Kamera“-Symbol um die Kamera-Anwendung zu öffnen und wechseln Sie in den Videomodus, indem Sie auf „☑“ tippen um ein Video aufzunehmen.

Gmail

Tippen Sie auf das Gmail-Symbol im Google Ordner. Wählen Sie dann das Symbol „✉“ in der unteren rechten Ecke um eine neue Nachricht zu erstellen. Benutzen Sie die Büroklammer, um Dateien oder Bilder anzuhängen. Tippen Sie auf „➤“ wenn Sie fertig sind. **Hinweis:** Sie müssen zuerst ein E-Mail-Konto erstellen.

Google Play Music

Tippen Sie auf das „Google Play Music“-Symbol im Google Ordner. Wählen Sie die Wiedergabeliste oder das Lied, das Sie abspielen wollen. Wiedergabelisten können nach Künstler, Album, Genre oder nach Ihrer eigenen Einteilung kategorisiert werden.

FM Radio

Stecken Sie Ihren Kopfhörerstecker in den Audioanschluss, tippen Sie auf das „FM Radio“-Symbol unter „Alle Apps“ „☰“ und wählen Sie dann eine Frequenz.

Google, Android und andere Marken sind Marken von Google LLC.

Iniziare

Come usare i tasti del telefono

Su qualsiasi schermata, toccare il tasto indietro "<" per tornare alla schermata precedente o uscire dall'applicazione. Toccare il tasto home "O" per tornare alla schermata iniziale. Toccare il tasto recente "□" per visualizzare tutti i programmi attualmente in uso. Toccare il tasto "on/off" per accendere o spegnere lo schermo e bloccarlo. Premere a lungo "on/off" per spegnere o riavviare il telefono. Tenere premuti contemporaneamente il tasto "on/off" e il tasto volume giù per fare uno screenshot.

Lingua

Toccare l'icona impostazioni. Andare su "Personale" e toccare "Lingua & Input", quindi selezionare la lingua preferita toccando "Lingua".

Chiamate

Toccare l'icona "Telefono", quindi toccare "☎" per selezionare il contatto che si vuole chiamare. O, semplicemente fare una chiamata immettendo il numero dopo aver selezionato l'icona "☎".

Messaggi Android™

Toccare l'icona Messaggi Android, quindi toccare "✉" per creare un nuovo messaggio. Immettere un nome o un numero nel campo "A" o scegliere qualcuno dalla lista dei contatti, quindi toccare "✓" e digitare il messaggio. Premere l'icona con la graffetta se si desidera allegare un'immagine, video o altri media. Una volta fatto, toccare "Invia".

Scrivere e copiare un testo

Il telefono darà suggerimenti mentre si scrive. Se si vuole copiare o tagliare il testo, premere il testo per alcuni secondi e usare le frecce di selezione per selezionare, o usare l'opzione "seleziona tutto", quindi copiare o incollare il testo.

Fotocamera

Toccare l'icona "fotocamera" per aprire la fotocamera. Il telefono supporta molte modalità immagine quali HDR, flash, bellezza ecc. Per accedere a queste modalità, selezionare l'icona "opzioni".

Google™ Foto

Toccare l'icona Google Foto nella cartella Google per aprire la galleria e visualizzare le foto, toccare una foto per aprirla. Toccare "✏" per entrare nella modalità modifica. È possibile aggiungere gli effetti colore, ruotare, ritagliare ecc. Cliccare "salva".

Videocamera

Toccare l'icona "fotocamera" per aprire la fotocamera e passare alla modalità "video" toccando "□" per registrare.

Gmail

Toccare l'icona Gmail nella cartella Google. Quindi selezionare l'icona "✉" sull'angolo in basso a destra per comporre un nuovo messaggio. Usare la graffetta per allegare file o immagini. Infine toccare "➤". **Nota:** Dapprima è necessario installare un account email.

Google Play Music

Toccare l'icona Google Play Music nella cartella Google. Selezionare la playlist o la canzone che si desidera ascoltare. Le playlist possono essere catalogate per Artista, Album, Genere o ciò che si è creato.

Radio FM

Collegare gli auricolari alla presa audio, toccare l'icona "Radio FM" in tutte le App "☰" e selezionare la frequenza.

Van start gaan

Hoe de toetsen van de telefoon gebruiken

Tik in eender welke scherm op de terug-toets "<" om terug te keren naar het voorgaande scherm of de applicatie te verlaten. Tik op de starttoets "O" om terug te keren naar het startvenster. Tik op de recent-toets "□" om alle programma's die momenteel openstaan te bekijken. Tik op de toets "aan/uit" om het scherm in of uit te schakelen en om het scherm te vergrendelen. Houd "aan/uit" ingedrukt om uw mobiele telefoon uit te schakelen of herstarten. Houd de toets "aan/uit" tegelijk met de toets volume-neer ingedrukt om een screenshot te maken.

Taal

Tik op het icoon van de instellingen. Verrol neerwaarts tot onder "Persoonlijk", tik op "Taal & input" en selecteer dan uw voorkeurtaal door te tikken op "Taal".

Oproepen

Tik op het icoon "Telefoon" en tik dan op "👤" om het gewenste contact te selecteren. Of maak eenvoudig een oproep door het nummer in te voeren nadat u het icoon "☎" heeft geselecteerd.

Android™ Messages

Tik op het icoon Android Messages en tik dan op "+" om een nieuw bericht aan te maken. Voer een naam of nummer in het veld "Aan" of kies iemand uit uw contactenlijst, tik dan op "✓" en voer uw bericht in. Druk op het icoon paperclip om een foto, video of andere media als bijlage toe te voegen. Tik op "Verzenden" wanneer u klaar bent.

Een bericht schrijven en kopiëren

De telefoon doet aanbevelen terwijl u een bericht intypt. Om tekst te kopiëren of knippen drukt u enkele seconden lang op de tekst en gebruikt u de selectiepijlen om te selecteren, of u gebruikt de optie "alles selecteren" om uw tekst te kopiëren of plakken.

Camera

Tik op het icoon "camera" om de camera te openen. Deze telefoon ondersteunt een waaier aan fotomoddi, zoals HDR, flits, Face beauty enz. Selecteer het icoon "opties" voor toegang tot deze modi.

Google™ Photos

Tik op het icoon Google Photos in de map Google om de galerie te openen en door uw foto's te bladeren. Tik op een foto om deze te openen, tik op "✍" om de modus bewerken binnen te gaan. U kunt kleurfilter-effecten toevoegen, draaien, uitsnijden enz. Klik op "opslaan".

Videocamera

Tik op het "camera" om de camera te openen en schakel over naar de modus "video" door te tikken op "□P" om op te nemen.

Gmail

Tik op het icoon Gmail in de map Google. Selecteer dan het icoon "✉" in de rechtsonder hoek om een nieuw bericht aan te maken. Gebruik de paperclip om bestanden of beelden als bijlage toe te voegen. Tik op "➤" wanneer u klaar bent. **Opmerking:** u moet eerst een e-mailaccount instellen.

Google Play Music

Tik op het icoon Google Play Music in de map Google. Selecteer de playlist of het nummer dat u wilt weergeven. Playlists kunnen worden gerangschikt per Artiest, Album, Genre of datgene wat u heeft aangemaakt.

FM-radio

Sluit oordoppen aan op het audiocontact, tik op het icoon "FM-radio" in Alle Apps "⋮" en selecteer een frequentie.

بدء الاستخدام

كيفية استخدام مفاتيح الهاتف المحمول

اضغط على مفتاح الرجوع "⏪"، في أي شاشة، للرجوع إلى الشاشة السابقة أو الخروج من التطبيق. اضغط على زر بداية الشاشة "⏴" للرجوع إلى الشاشة الرئيسية. اضغط على الزر الأخير "⏴" لعرض جميع البرامج قيد الاستخدام حاليًا. اضغط على زر "فتح/إغلاق"، لفتح أو إغلاق الشاشة وقفل الشاشة. اضغط مع الاستمرار على "تشغيل/إيقاف" لإغلاق الهاتف المحمول أو إعادة تشغيله. اضغط مع الاستمرار على زر "تشغيل/إيقاف" وزر خفض مستوى الصوت في وقت واحد لالتقاط صورة شاشة.

اللغة

"اضغط على رمز الإعدادات مرر لأسفل تحت "شخصي" واضغط على "اللغة والإدخال"، ثم اختر لغتك المفضلة بالضغط على "اللغة."

المكالمات

اضغط على رمز "الهاتف"، ثم اضغط على "👤" جهة الاتصال التي ترغب في الاتصال بها. أو، يمكنك ببساطة إجراء مكالمة عن طريق "☎" إدخال الرقم بعد تحديد رمز.

Android™ Messages

اضغط على رمز رسائل أندرويد، ثم اضغط على "➕" لإنشاء رسالة جديدة. أدخل اسمًا أو رقمًا في حقل "إلى" أو اختر اسمًا من قائمة جهات الاتصال. ثم اضغط على "✓"، وأدخل رسالتك. اضغط على رمز المشبك إذا كنت ترغب في إرفاق صورة أو مقطع فيديو أو أي وسائل أخرى. عند الانتهاء من الإرفاق، اضغط على "إرسال".

كتابة نص ونسخه

ما إن تكتب رسالة، سيعرض لك الهاتف اقتراحات. إذا كنت تريد كتابة نص أو قصه، اضغط باستمرار على النص ليضع ثوان واستخدم سهمي التحديد في التحديد، أو استخدم خيار "تحديد الكل"، ثم انسخ النص أو الصقه.

الكاميرا

Face beauty وflash وHDR اضغط على رمز "الكاميرا" لفتح الكاميرا. يدعم الهاتف مجموعة متنوعة من أنماط الصور مثل "وغيرهم. للوصول إلى هذه الأنماط، حدد رمز "الخيارات".

Google™ Photos

لفتح معرض الصور لتصفح صورك، اضغط على أي صورة Google في المجلد (Google Photos) اضغط على رمز صور غوغل "لفتحها. اضغط على "✏" للدخول إلى وضع التحرير. يمكنك إضافة تأثيرات مرشح الألوان والتدوير والقص وما إلى ذلك. انقر فوق "حفظ".

كاميرا فيديو

اضغط على رمز "الكاميرا" لفتح الكاميرا ثم انتقل إلى وضع "فيديو" عن طريق الضغط على "📹" للتلصيق.

Gmail

من مجلد غوغل. ثم حدد رمز "✉" في الزاوية اليمنى السفلية لإنشاء رسالة جديدة. استخدم (Gmail) اضغط على رمز جيميل المشبك لإرفاق الملفات أو الصور. اضغط على "➤" عند الانتهاء. ملحوظة: يتعين عليك إنشاء حساب بريد إلكتروني أولاً.

Google Play Music

من مجلد غوغل. حدد قائمة التشغيل أو الأغنية التي ترغب في (Google Play Music) اضغط على رمز موسيقى غوغل بلاي تشغيلها. يمكن ترتيب قوائم التشغيل حسب الفنان أو الألبومات أو النوع أو حسب ما أنشأته.

راديو إف إم

قم بتوصيل سماعات الأذن بمقبس الصوت، ثم اضغط على رمز "راديو إف إم" من جميع التطبيقات "⋮" وحدد التردد.

Mengenal

Menggunakan tombol-tombol pada telepon

Pada tampilan layar apapun, sentuh tombol kembali “◀” untuk kembali ke layar sebelumnya atau keluar dari aplikasi. Sentuh tombol awal “□” untuk kembali ke halaman utama. Sentuh tombol “□” untuk menampilkan aplikasi yang sedang aktif. Sentuh tombol “on/off”, untuk menyalakan layar dan mengunci layar. Tekan dan tahan tombol “on/off” untuk mematikan atau memulai ulang perangkat anda. Tekan dan tahan tombol “on/off” bersamaan dengan tombol untuk mengecilkan volume untuk menangkap layar.

Bahasa

Pilih ikon pengaturan. Geser ke bawah, pilih “Pribadi” dan pilih “Bahasa dan masukan”, kemudian pilih bahasa yang dikehendaki dengan memilih menu “Bahasa”.

Telepon

Pilih ikon “Ponsel” kemudian pilih ikon “👤” untuk mencari kontak yang ingin dihubungi. Atau, lakukan panggilan telepon dengan memasukkan nomor telepon setelah menekan ikon “☎”

Android™ Messages

Pilih ikon Android Messages , lalu pilih ikon “+” untuk membuat pesan baru. Masukkan nama atau nomor ke dalam kolom “Ke” atau pilih dari daftar kontak, kemudian pilih “✓”, an masukkan pesan anda. Pilih ikon penjepit kertas untuk mengirim gambar, video atau media lain. Ketika selesai, pilih “Kirim”.

Menulis dan menyalin pesan

Telepon akan menampilkan rekomendasi kata-kata saat anda mengetik, jika ingin menyalin atau memotong teks, tekan dan tahan teks selama beberapa detik, gunakan cursor/panah untuk memilih atau gunakan pilihan “Pilih Semua” kemudian salin atau tempel pesan anda.

Kamera

Pilih ikon “Kamera” untuk mengambil gambar atau video. Perangkat ini mendukung pengambilan gambar dalam berbagai mode pilihan seperti HDR, flash, Face Beauty, dll. Untuk mengakses mode pilihan tersebut, pilih ikon “Pilihan”.

Google™ Photos

Pilih ikon Google Photos pada folder Google untuk membuka galeri dan memilih foto-foto anda, pilih sebuah foto untuk membukanya. Pilih ikon “✍️” untuk masuk ke mode sunting. Anda bisa memilih efek filter warna, memutar foto, memotong foto, dsb. Klik “Simpan”.

Kamera Video

Buka kamera dengan memilih ikon “Kamera” dan geser ke mode video dengan menyetuh ikon “📹” untuk mulai merekam.

Gmail

Pilih ikon Gmail pada folder Google . Pilih ikon “✉️” yang ada di pojok kanan bawah untuk membuat pesan baru. Sentuh ikon penjepit kertas untuk mengirim dokumen atau gambar. Pilih ikon “➤” ketika selesai. **Catatan** : Anda harus membuat sebuah akun email terlebih dahulu.

Google Play Music

Pilih ikon Google Play Music pada Google Folder. Pilih daftar putar atau lagu yang ingin anda putar. Daftar putar dapat dikategorikan berdasarkan Artis, Album, Genre, atau sesuai dengan yang sudah anda tentukan.

Radio FM

Hubungkan earphone ke audio jack, cari dan pilih ikon Radio FM pada “📻” kemudian pilih frekuensi yang anda inginkan.

Safety information

- This section contains important information about the operation of your device, it also contains information about how to use the device safely. Read this information carefully before using your device.

Electronic device

Do not use your device if using the device is prohibited.

Do not use the device if doing so causes danger or interference with other electronic devices.

Interference with medical equipment

- Follow rules and regulations set forth by hospitals and health care facilities. Do not use your device where prohibited.
- Some wireless devices may affect the performance of hearing aids or pacemakers. Consult your service provider for more information.
- Pacemaker manufacturers recommend that a minimum distance of 15 cm be maintained between a device and a pacemaker to prevent potential interference with the pacemaker. If using a pacemaker, hold the device on the side opposite the pacemaker and do not carry the device in your front pocket.

Protecting your hearing when using a headset

- To prevent possible hearing damage, do not listen at high volume levels for long periods.
- Using a headset at high volumes may damage your hearing. To reduce this risk, lower the headset volume to a safe and comfortable level.
- Exposure to high volumes while driving may cause distraction and increase your risk of an accident.

Areas with flammables and explosives

- Do not use the device where flammables or explosives are stored (in a gas station, oil depot, or chemical plant, for example). Using your device in these environments increases the risk of explosion or fire. In addition, follow the instructions indicated in text or symbols.
- Do not store or transport the device in containers with flammable liquids, gases, or explosives.

Traffic security

- Observe local laws and regulations while using the device. To reduce the risk of accidents, do not use your wireless device while driving.
- Concentrate on driving. Your first responsibility is to drive safely.
- Do not hold the device while driving. Use hands-free accessories.
- When you must make or answer a call, pull off the road safely and park the vehicle first.
- RF signals may affect the electronic systems of motor vehicles. For more information, consult the vehicle manufacturer.
- Do not place the device over the air bag or in the air bag deployment area in a motor vehicle. Doing so may hurt you because of the strong force when the air bag inflates.
- Wireless devices may interfere with the airplane's flight system. Do not use your device where wireless devices are not allowed according to the airplane company's regulations.

Operating environment

- Avoid dusty, damp, or dirty environments. Avoid magnetic fields. Using the device in these environments may result in circuit malfunctions. Do not use your device during thunderstorms

to protect your device against any danger caused by lightning.

- Ideal operating temperatures are 0 °C to 35 °C. Ideal storage temperatures are -20 °C to 45 °C. Extreme heat or cold may damage your device or accessories.
- Do not expose your device to direct sunlight (such as on a car dashboard) for prolonged periods.
- To protect your device or accessories from fire or electrical shock hazards, avoid rain and moisture.
- Keep the device away from sources of heat and fire, such as a heater, microwave oven, stove, water heater, radiator, or candle.
- Do not place sharp metal objects, such as pins, near the earpiece or speaker. The earpiece may attract these objects and result in injury.
- Stop using your device or applications for a while if the device is overheated. If skin is exposed to an overheated device for an extended period, low temperature burn symptoms, such as red spots and darker pigmentation, may occur.
- Do not use your device's camera flash directly in the eyes of people or pets. Otherwise temporary loss of vision or damage to the eyes may occur.
- Do not touch the device's antenna. Otherwise, communication quality may be reduced.
- Do not allow children or pets to bite or suck the device or accessories. Doing so may result in damage or explosion.
- Observe local laws and regulations, and respect the privacy and legal rights of others.

Child safety

- Comply with all precautions with regard to child's safety. Letting children play with the device or its accessories may be dangerous. The device includes detachable parts that may present a choking hazard. Keep away from children.
- The device and its accessories are not intended for use by children. Children should only use the device with adult supervision.

Accessories

- Using an unapproved or incompatible power adapter, charger or battery may cause fire, explosion or other hazards.
- Choose only accessories approved for use with this model by the device manufacturer. The use of any other types of accessories may void the warranty, may violate local regulations and laws, and may be dangerous.
- If the power cable is damaged (for example, the cord is exposed or broken), or the plug loosens, stop using it at once. Continued use may lead to electric shocks, short circuits, or fire.
- Do not touch the power cord with wet hands or pull the power cord to disconnect the charger.
- Do not touch the device or the charger with wet hands. Doing so may lead to short circuits, malfunctions, or electric shocks.
- If your charger has been exposed to water, other liquids, or excessive moisture, only an authorized service center has the right to inspect.

Battery safety

- Do not connect battery poles with conductors, such as keys, jewelry, or other metal materials. Doing so may short-circuit the battery and cause injuries or burns.

- Keep the battery away from excessive heat and direct sunlight. Do not place it on or in heating devices, such as microwave ovens, stoves, or radiators. Batteries may explode if overheated.
- Do not attempt to modify or remanufacture the battery, insert foreign objects into it, or immerse or expose it to water or other liquids. Doing so may lead to fire, explosion, or other hazards.
- If the battery leaks, ensure that the electrolyte does not make direct contact with your skins or eyes. If the electrolyte touches your skins or splashes into your eyes, immediately flush with clean water and consult a doctor.
- In case of battery deformation, color change, or overheating while charging or storing, immediately stop using the device and remove the battery. Continued use may lead to battery leakage, fire, or explosion.
- Do not put batteries in fire as they may explode. Damaged batteries may also explode.
- Dispose of used batteries in accordance with local regulations. Improper battery use may lead to fire, explosion, or other hazards.
- Do not allow children or pets to bite or suck the battery. Doing so may result in damage or explosion.
- Do not smash or pierce the battery, or expose it to high external pressure. Doing so may lead to a short circuit or overheating.
- Do not drop the device or battery. If the device or battery is dropped, especially on a hard surface, it may be damaged.
- If the device standby time shortens significantly, replace the battery.

Cleaning and maintenance

- Keep the device and accessories dry. Do not attempt to dry it with an external heat source, such as a microwave oven or hair dryer.
- Do not expose your device or accessories to extreme heat or cold. These environments may interfere with proper function and may lead to fire or explosion.
- Avoid collision, which may lead to device malfunctions, overheating, fire, or explosion.
- Before you clean or maintain the device, stop using it, stop all applications, and disconnect all cables connected to it.
- Do not use any chemical detergent, powder, or other chemical agents (such as alcohol and benzene) to clean the device or accessories. These substances may cause damage to parts or present a fire hazard. Use a clean, soft, and dry cloth to clean the device and accessories.
- Do not place magnetic stripe cards, such as credit cards and phone cards, near the device for extended periods of time. Otherwise the magnetic stripe cards may be damaged.
- Do not dismantle or remanufacture the device and its accessories. This voids the warranty and releases the manufacturer from liability for damage. In case of damage, contact an authorized service center for assistance or repair.
- If the device screen is broken in a collision, immediately stop using the device. Do not touch or attempt to remove the broken parts. Promptly contact an authorized service center.

Emergency calls

- The availability of emergency calls is subject to your cellular network quality, service provider policy, and local laws and regulations. Never rely solely on your device for critical communications like medical emergencies.

Environmental protection

- The device and its accessories (if included), such as the power adapter, headset, and battery should not be disposed of with household garbage.
- Disposal of the device and its accessories is subject to local regulations. Support proper collection and recycling.

Safety precautions

- Use of wireless hands-free system (headphone, headset) with a low power Bluetooth emitter.
- Make sure the cell phone has a low SAR.
- Keep your calls short or send a text message (SMS) instead. This advice applies especially to children, adolescents and pregnant women.
- Use cell phone when the signal quality is good.
- People having active medical implants should preferably keep the cell phone at least 15 cm away from the implant.

Disposal and recycling information



This symbol on the device or on its packaging indicates that the device (including its electrical accessories) should not be disposed of as normal household garbage. Do not dispose of your device as unsorted municipal waste. The device should be handed over to an authorized collection center for recycling or proper disposal at the end of its life.

Battery Caution

1. Use only NUU-approved batteries, chargers, and cables to charge your phone. Unapproved chargers or cables can cause the battery to explode or damage the device.
2. Use only NUU-approved batteries, chargers and cables. Use unapproved batteries, chargers and cables may cause safety issue and the warranty will be lost.
3. You can recharge your battery many times, but all batteries have a limited lifespan. If you notice a significant deterioration in your phone's battery life, you will need to purchase a replacement battery for replacement. If the battery is built-in in the phone, do not attempt to remove built-in batteries and contact an authorized NUU service center for a replacement.
4. Your phone may become warm after prolonged use or when exposed to high ambient temperatures. If your phone becomes hot to the touch, unplug the USB cable, disable non-essential features, and avoid prolonged skin contact. Place your phone in a cool location and allow it to cool down to room temperature.
5. Charging times may vary depending on the ambient temperature and the remaining battery level.
6. Avoid using your phone when it is charging. Do not cover your phone or the charger when it is charging.

CAUTION

1. Use careful with the earphone maybe possible excessive sound pressure from earphones and headphones can cause hearing loss



2. CAUTION : RISK OF EXPLOSION IF BATTERY IS REPLACED BY AN INCORRECT TYPE. DISPOSE OF USED BATTERIES ACCORDING TO THE INSTRUCTIONS

3. The product shall only be connected to a USB interface of version USB2.0
4. Adapter shall be installed near the equipment and shall be easily accessible
5. Operation temperature:-20~35°C
6. The plug considered as disconnect device of adapter
7. The device complies with RF specifications when the device used at 0.5cm from your body

8. AC adapter:

Adapter(1)

Model No.:HJ-0501000B3-EU

Input: AC100-240V, 50/60Hz, 0.15 A

Output: DC 5.0V, 1.0A

Adapter(2)

Model No.:HJ-0501000V5

Input: AC100-240V, 50/60Hz, 0.15 A

Output: DC 5.0V, 1.0A

SUN CUPID TECHNOLOGY (HK) LIMITED hereby declares that this LTE mobile phone is in compliance with the essential requirements and other relevant provisions of Directive 2014/53/EU

This information has to be presented in such a way that the user can readily understand it. Typically, this will necessitate translation into every local language (required by national consumer laws) of the markets where the equipment is intended to be sold. Illustrations, pictograms and using international abbreviations for country names may help reduce the need for translation.

Max power:

GSM900: 33.68dBm

DCS1800: 30.81dBm

WCDMA 2100(Band I): 24.56dBm

WCDMA 900(Band VIII):23.96 dBm

LTE Band 1:24.52 dBm

LTE Band 3:24.41 dBm

LTE Band 7:23.89 dBm

LTE Band 8: 24.06 dBm

LTE Band 20: 23.37 dBm

BT:-0.51dBm

BLE:-0.60dBm

2.4Gwifi:12.08 dBm

NFC:-26.01 dB μ A

GSM 900: 880MHz~915MHz,

DCS 1800: 1710MHz~1785MHz

WCDMA 900(Band VIII): 880MHz~915MHz,

WCDMA 2100(Band I): 1920MHz~1980MHz

LTE Band 1:1920MHz~1980MHz,

LTE Band 3: 1710MHz~1785MHz,

LTE Band 7: 2500MHz~2570MHz,

LTE Band 8: 880MHz~915MHz,

LTE Band 20: 832MHz~862MHz,

Bluetooth /BLE: 2402MHz~2480MHz

2.4G WiFi: 2412MHz~2472MHz

NFC:13.56MHz

GPS:1575.42MHz

VHF band II: 87.5 MHz to 108 MHz

GSM /WCDMA/LTE/BT/WIFI/GPS/FM and NFC can be used in Europe without restriction.



everyday genius

Made in China



Warranty information

Please visit our website for details on warranty information.

Warranty Registration

Register Your Device

Thank you for choosing NUU mobile. To receive helpful tips and faster tech support, register your device online at

Hong Kong:

intl.nuumobile.com/product-registration/

US:

us.nuumobile.com/my-account/product-registration

UK and Europe:

uk.nuumobile.com/product-registration/

Indonesia:

Please fill up the warranty card in the package, and call for the warranty to begin.

India:

care@nuumobile.in

Customer Support

Questions? Let us help. We're here to support you.

Hong Kong:

Service Center: 16F, CEO Tower, 77 Wing Hong St. Kowloon, Hong Kong.
Phone: (852) 2725-0161
HK hours: M-F 9:00am-5:30pm CT
Email: cs@nuumobile.com

US:

Phone: Toll Free: 844-NUU-3365
U.S. hours: 9am-6pm ET, chat: M-F 24hrs
Email: support@nuumobile.com

UK:

Phone: 0333 121 0239
UK hours: Mon-Sat 8:00am - 7:00pm
Sun 10:00am - 4:00pm
Email: support@uk.nuumobile.com
Service Center: 119 King Henry's Road, London, NW3 3RB

Europe:

Support: nuumobile.com/europe

Italy:

Phone: 199 309 314
Mon-Fri 9:00am - 1:00pm
Mon-Fri 2:00pm - 6:00pm

Indonesia:

Service Center: JAKARTA
Ruko Roxy Mas Blok C4 No. 4
Jl. KH. Hasyim Ashari No. 125
Cideng, Jakarta Pusat 10150
Phone: 021 - 633 7359

BANDUNG
Jl. Leuwi Panjang No. 101 B,
Situsaeur,Bojongloa Kidul,
Phone: 022 - 42822704
Operasional: Hari Senin-Jum'at, Jam 10-5 sore
Hari Sabtu, Jam 10-1 siang
Hari Minggu & hari libur nasional tutup

India:

Service Center: 201,Quantum Tower, Rambaug Lane, Off S. V. Road, (Malad)
West, Mumbai, Maharashtra, India, 400064.
Phone: 1800-121-0688
Mon-Sat 10:00am-7:00pm
Email: customercare@nuumobile.in



Learn more about NUU Mobile products,
features and accessories at



www.nuumobile.com